

Versati™



Versati™ Tabletop Centrifuge Models: TCV-1500 and TCR-1500



Versati™ Micro Centrifuge Models: MCV-88 and MCR-88

Centrifuge

Best Choice for High Performance and Superior Quality Centrifuge

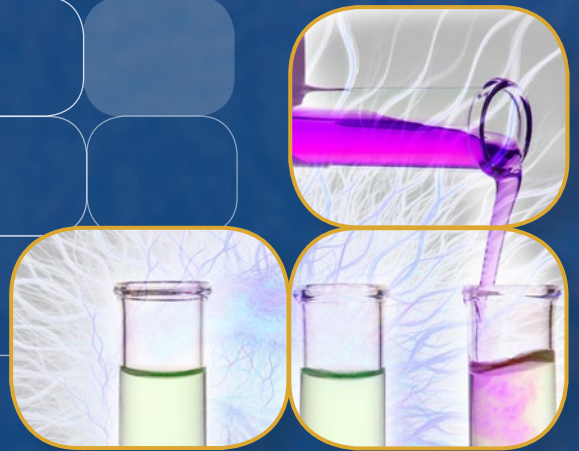

ESCO

WORLD CLASS. WORLDWIDE.



Welcome to Esco

Esco's Vision is to provide enabling technologies for scientific discoveries to make human lives healthier and safer.



The Esco Group of Companies is committed to deliver innovative solutions for the clinical, life sciences, research, industrial, laboratory, pharmaceutical, and IVF community. With the most extensive product line in the industry, Esco have passed a number of international standards and certifications, and is operating under ISO 90001, ISO 14001, and ISO 13485. Esco represents innovation and forward-thinking designs, that are of the highest standard quality since 1978.

Availability and Accessibility. Esco has headquarters in Singapore, Indonesia, and Philippines, with manufacturing facilities are located in Asia and Europe. Research and Development (R&D) is conducted worldwide spanning the US, Europe and Asia. Sales, services and marketing subsidiaries are located in 42 major markets including US, UK, Japan, China and India. Esco regional distribution centers are located in Singapore, Malaysia, Thailand, Vietnam, Myanmar, Indonesia, Philippines, Bangladesh, Hong Kong, Taiwan, South Korea, China, Japan, India, UAE, Central and South Africa, Denmark, Germany, Italy, Lithuania, Russia, United Kingdom, and USA. Because of our worldwide presence, you can be sure that Esco is within your reach.

High Quality, Reliable, and Dependable. Esco products are of high quality, reliable, and dependable; assuring customers of research accuracy. Cross functional teams from Esco Production, R&D, Quality Assurance, and Senior Management, are regularly assembled to review and implement areas for improvement.

Esco Cares for Your Safety. Esco focuses on providing safety not just for your samples but also for you and the environment.

Esco Cares for Your Comfort. Building ergonomic designs and reducing noise levels of the units ensures comfort for our users.

Esco Cares for the Environment. One in every four of Esco's employees is involved in R&D and a number of them evaluate new components and/or designs to produce energy efficient equipment. Being GREEN is more than just modifying parts used to produce a new energy efficient technology, it is also embodied in the every aspect of the company.

Customer Service and Support. Our service does not stop once purchase has been done. Esco gives on-time customer service and offers end-user seminars, service training, preventive maintenance, and provides educational materials and informative videos.

As Esco takes the opportunity to respond to the world's needs, we aim not only to contribute in the advancement of scientific discoveries but also in making the world a safer, healthier, and better place to live in.

Versati™

MCV and MCR • TCV and TCR • Centrifuge

Products and Application

Life Sciences Laboratory Equipment

Sample Preparation

- Class I Biological Safety Cabinets
- Class II Microbiological Safety Cabinets
- Class II Type A2 Biological Safety Cabinets
- Class II Type B1 Biological Safety Cabinets
- Class II Type B2 Biological Safety Cabinets
- Class III Biological Safety Cabinets
- Horizontal Laminar Flow Clean Benches
- Vertical Laminar Flow Clean Benches
- Laboratory Animal Research Workstations
- Laboratory Centrifuges

Sample Cultivation

- CO₂ Incubators, Direct Heat Air-Jacketed
- CO₂ Incubators with Cooling System
- CO₂ Incubators with Stainless Steel Exterior
- Laboratory Shakers

Sample Handling and Analysis

PCR Thermal Cyclers

- Conventional Thermal Cyclers

PCR Sample Handling

- Microplate Shakers
- PCR Cabinets

Sample Storage & Sample Protection Solutions

- Ultra-low Temperature Freezers
- Lab Refrigerators and Freezers
- Sample Database Management Software
- Intelligent Remote Monitoring Application Protocol
- Remote Monitoring, Datalogging, Programming Software
- Wireless Monitoring System

Chemical Research

- Ductless Fume Hoods
- Laboratory Fume Hoods
- Fume Hood Airflow Monitors
- Exhaust Blowers
- Powder Weighing Balance Enclosures
- Filtered Storage Cabinet

General Equipment

Laboratory Thermostatic Products

- Laboratory Oven
- Laboratory Incubator
- Refrigerated Incubator
- Natural Convection Incubator

Forensic Sciences

- Evidence Drying Cabinet

Medical / IVF Equipment

Controlled Embryo Handling

- Fertilisafe™ ART Workstation
- AVT-I Anti Vibration Table
- Semi Closed Environment IVF

Safe Embryo Culture

- MIRI® Multi room Benchtop Incubator
- CelCulture® CO₂ Incubator
- Mini MIRI® Humidified Benchtop Incubator

Innovative Time Lapse Imaging

- MIRI® Time-lapse Incubator

Accurate Quality Control

- MIRI® GA Gas and Temperature Validation Unit
- MIRI® GA Mini Gas Validation Unit

Unique Consumables

- CultureCoin

Healthcare

Esco Pharma Products

Airflow Containment Products

- Pharmacon® Downflow Booths
- Ceiling Laminar Airflow Units
- Laminar Flow Horizontal/Vertical Trolley
- Enterprise™ Laminar Flow Straddle Unites
- Cytoculture™ Cytotoxic Safety Cabinets

Isolation Containment

- Aseptic Containment Isolator (ACTI)
- Weighing and Dispensing Containment Isolator (WDCI)
- General Processing Platform Isolator (GPPI)
- Containment Barrier Isolator (CBI)
- Turbulent Flow Aseptic (Grade A) Isolator (TFAI)
- Isoclean® Healthcare Platform Isolator (HPI)
- Streamline® Compounding Isolators (SCI)
- Technetium Dispensing Isolators
- Blood Cell Labeling Isolators
- Open and Closed Restricted Barrier Access Systems (RABS)

Cross Contamination Facility Integrated Barrier

- BioPass™ Pass Through
- Infinity® Air Shower Pass Box
- Cleanroom Air Shower
- Infinity® Cleanroom Transfer Hatch
- Infinity® Pass Box
- Soft capsule® Soft Wall Cleanroom
- Dynamic Passboxes and Dynamic Floor Laminar Hatches
- Laminar Flow Storage Cabinet

Ventilation Containment

- Ventilated Balance Enclosure

VacciXcell Products

Bioreactors and Fermenters

- CelCradle™
- TideXcell™
- VacciXcell™ Hybrid Bioreactor

Cell Culture Monitoring, Media and Consumables

- Super Plus™
- Plus™ Vero
- Plus™ MDCK
- Plus™ MDCK II
- BioNOC™ II macrocarriers
- GlucCell™ Glucose Monitoring System
- CVD Kit

Filling Line Equipment

- Filling Line Isolators
- cRabs (close restricted access barriers)
- oRabs (open restricted access barriers)

Integrated Solutions

- Cell Processing Isolator
- Cell Processing Center

TaPestle Rx Products and Services

PRODUCTS

Pharmacy Automation and Compounding Supply

- Compounding Pharmacy Isolators (SCI, HPI, CBI, GPPI)
- Safety Cabinets and Enclosures (Class II BSC, VBE, LFC)
- Radiopharmacy Hoods and Isolators
- Aseptic Filling Systems

Healthcare and Laboratory Construction Components

- Prefabricated Walls (Airecell®)
- Prefabricated Containerized Facility (Prefab™)
- Series Ceiling Systems
- Hygienic/Hermetic Door Systems
- Surgical Scrub Sinks
- Vinyl Tiles and Epoxy
- Laboratory Fit-outs
 - Worktops
 - Frames
 - Specialty Storage cabinets
 - Service Spines & Reagent Shelving

SERVICES

- Conceptualization
- Planning
- Procurement
- Installation

FACILITY DESIGNS

- Process Architecture
- Biocontainment/Biosafety
- Pharmacy Compounding/Nuclear Medicine
- Cleanroom, Vaccine and Cell Processing
- Laboratory
- Containerized Facility
- ART/IVF
- Cold Chain

Esco offers the best choice for high performance and superior quality centrifuge—Versati™ centrifuges. It is equipped with maintenance-free motors, durable mechanism, and intelligent Versati™ microprocessor control system that offers extreme reliability and safety. Versati™ has a robust versatility covering micro centrifuge and low-to-high speed general-purpose centrifuge with variety of rotors, adapters, and accessories to fit all your application needs and suit various consumable tubes, strips, and plates.

Our micro centrifuge models— MCV (ventilated) and MCR (refrigerated) stand out with outstanding features and versatility. Both have maximum speed of 15,000 rpm (21,380 x g), maximum volume capacity of 44 x 1.5/ 2.0 ml, and can accommodate 12 x 5 ml reaction tubes or 4 x 8 PCR strips per run. Additionally, our micro ventilated centrifuge has a hematocrit rotor which can accommodate 24 capillaries per run. Esco Versati™ centrifuges' compact design saves space in your lab and its low noise



DISTINCT CONTROL PANEL AND INTELLIGENT VERSATI™ MICROPROCESSOR CONTROL SYSTEM

- Big rotary knob and buttons, convenient for rotation and operation.
- Large LCD screen with clear indication of running condition including rotor, speed, time etc.
- Operation panel is water-proof, can well protect the inner electric elements.
- Microprocessor with speed self-tested system.



Versati™ Tabletop Centrifuge TCV-1500 and TCR-1500



DIVERSE CHOICES OF ROTORS

- Made of aluminum alloy.
- Automatic rotor recognition function (for TCV/TCR only) minimizes the need for manual settings.
- Powerful motor provides high RCF (Relative Centrifugal Force) up to 21380 x g for MCV/ MCR, 21382 x g for TCV and 24320 x g for TCR.
- As many as 7 rotors with wide range of capacity for MCV, 6 rotors for MCR, and 12 rotors for TCV/TCR to meet all your needs.



Versati™ Micro Centrifuge MCV-88 and MCR-88



INTEGRATED DESIGN OF INTERIOR CENTRIFUGE CHAMBER

- The side plate and baseboard of centrifuge chamber are made by one-time punch forming of a whole piece of steel plate.
- No dead angle within the chamber, easy-to-clean and can reduce pollution at the greatest possibility.

performance is preferred in any working area. The refrigerated model's powerful refrigeration system keeps samples at temperature of as low as 4°C during a continuous run at 21380 x g.

For tabletop centrifuge models, Esco Versati™ Tabletop Ventilated Centrifuge (TCV) and Tabletop Refrigerated Centrifuge (TCR) also excel among the same level of products with their versatility, running features, and easy handling. It can act as different type of centrifuge to meet all your application needs—centrifuge for DNA precipitations, high-capacity and low-to-high speed general-purpose centrifuge for cell application. Both have available fixed-angle and swing-bucket rotors with a maximum capacity of up to 6 x 250 ml (for fixed-angle rotor) and 4 x 250 ml (for swing-bucket rotor). In addition, both have an available microtiter plate rotor with maximum capacity of up to 6 plates. The tabletop ventilated centrifuge maximum speed and rcf is 15,000 rpm (21,382 x g) while the tabletop refrigerated centrifuge maximum speed and rcf is 16,000 rpm (24,320 x g).

SAFETY LID LOCK

- Motor driven lid lock, ensures safety and reliability.
- The lid can only be opened once the rotor stops, and speed indicator is 0.
- Smooth, automatic, and electromagnetic lid allows one-hand-operation



EMERGENCY SWITCH

- In case of power failure or malfunction, the lid of the centrifuge can be opened manually via the emergency switch in order to protect your samples.



MAINTENANCE-FREE, BRUSHLESS MOTOR

- Equipped with German-originated motor, requiring neither bearing replacement nor change oil.
- No carbon brush, low interference. Electric-spark-free that ensures no interference to radio equipment.
- Low noise and smooth operation with superior mechanism design.
- Prolongs the lifespan and saves maintenance cost.



POLISHED AND PRACTICAL APPEARANCE

- External surfaces are powder coated Esco ISOCIDE™ to eliminate 99.9% of surface bacteria within 24 hours of exposure. This technology ensures relatively aseptic condition.
- Provides healthier, safer and cleaner lab environment.

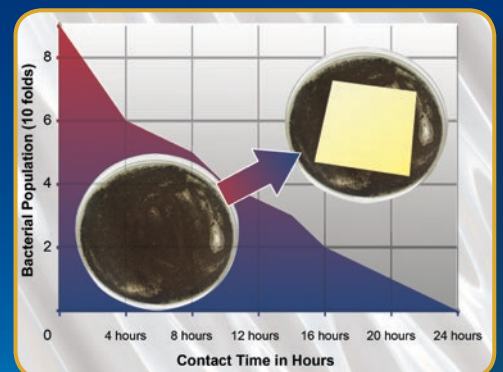

TCV Engineering Drawing

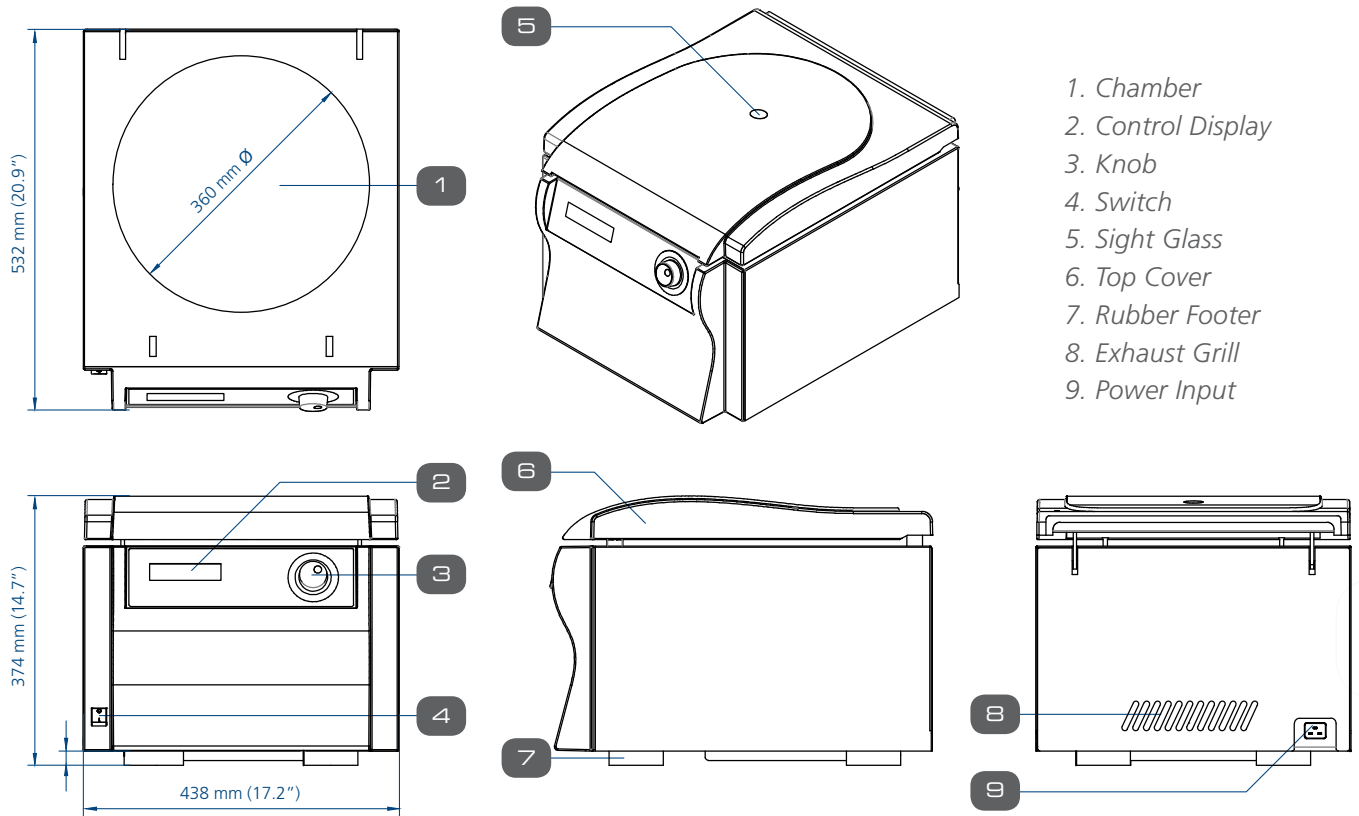

TCR Engineering Drawing

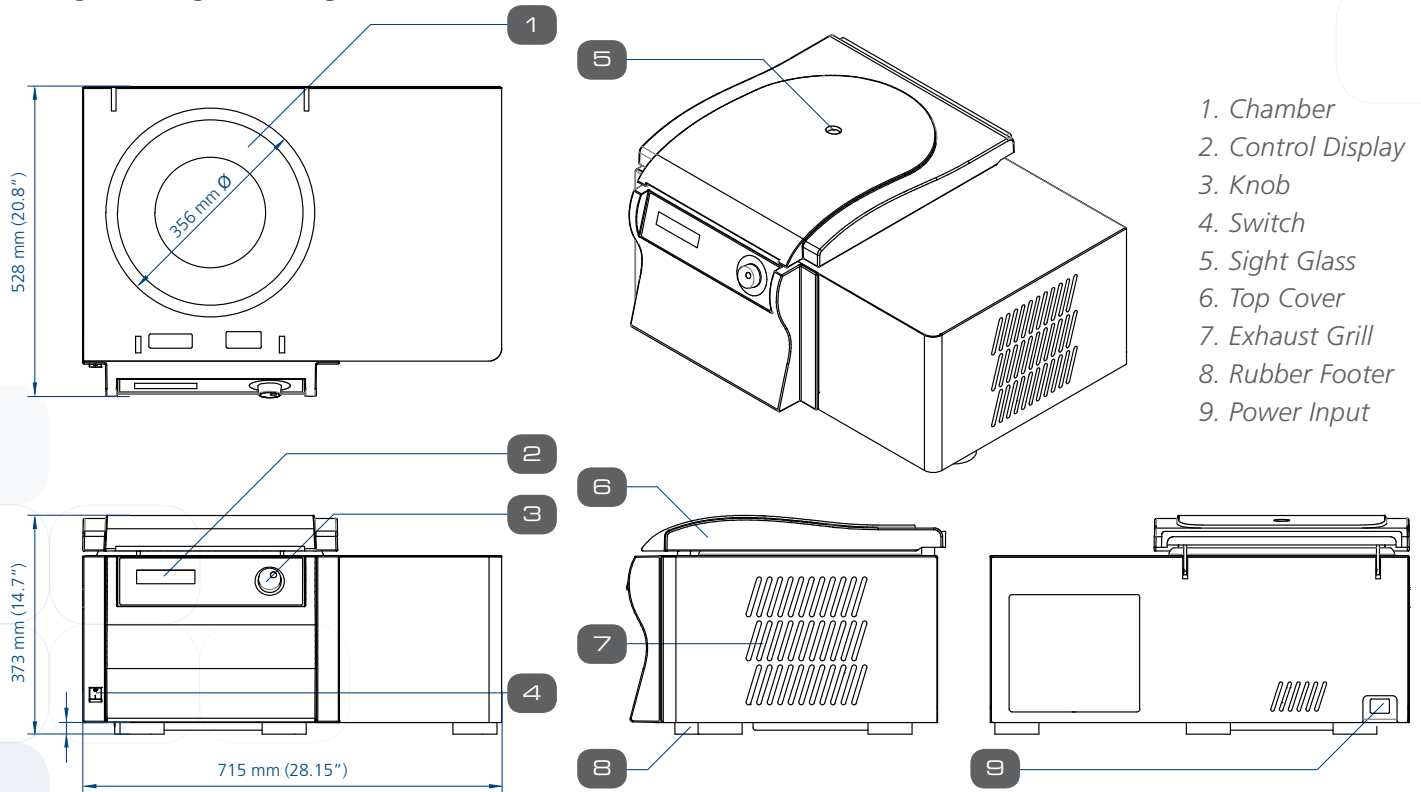

MCV Engineering Drawing

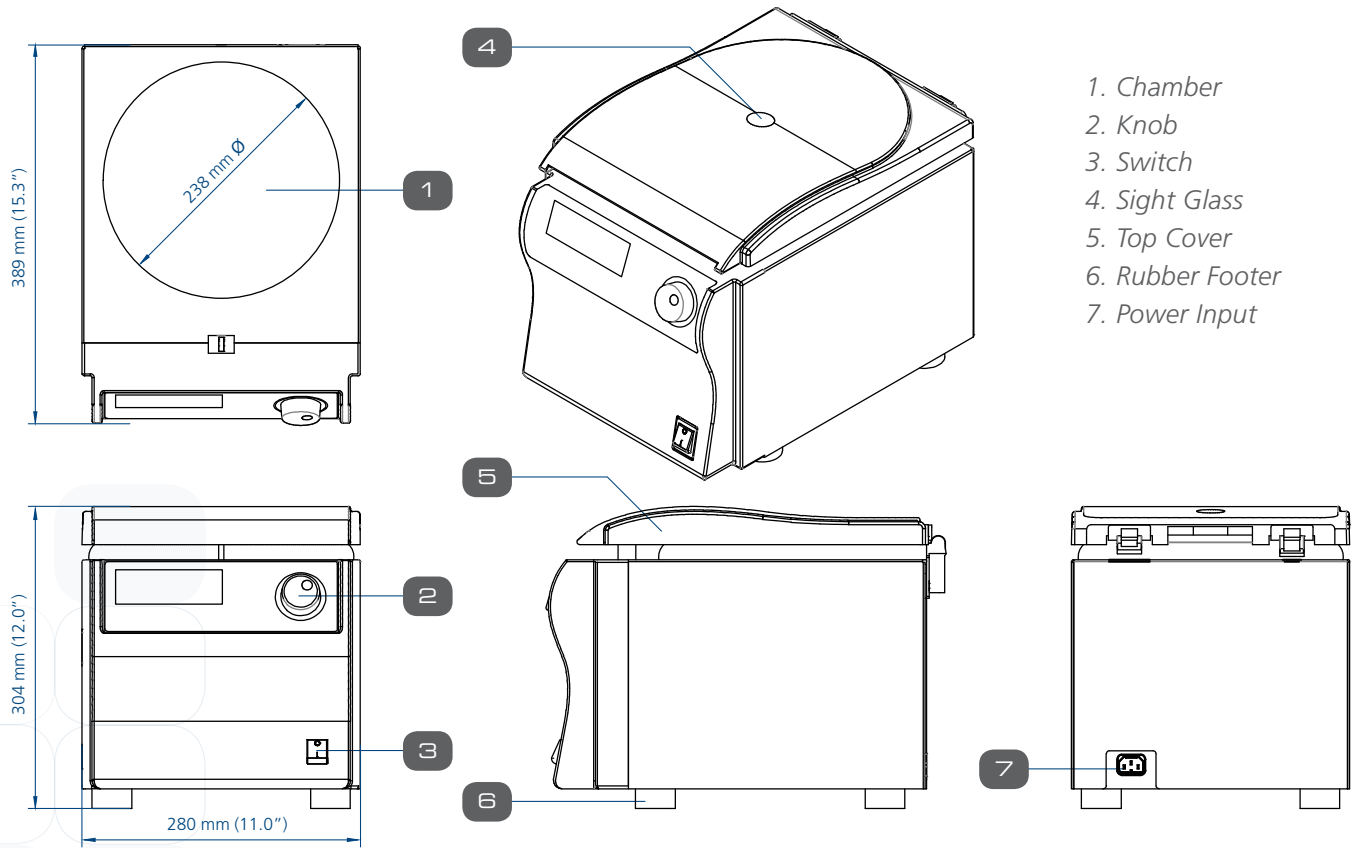

MCR Engineering Drawing

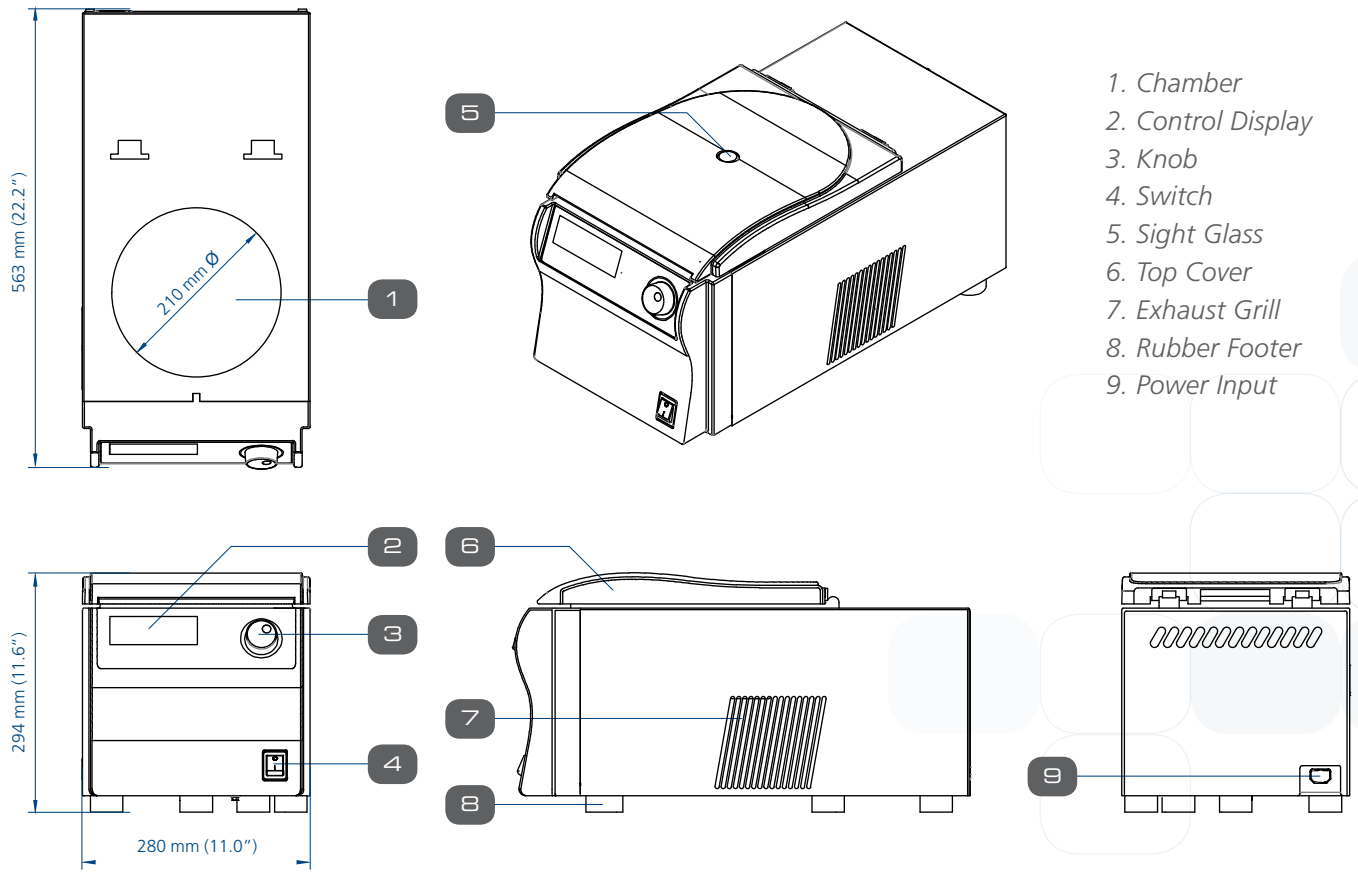

Versatile and Outstanding Features

Based on German manufacturing technology, especially in motor and rotor design, Versati™ centrifuges have elaborate mechanical performance not only in speed but also in flexibility and versatility.

- **Compact Design**

- Exceptional capability in compact dimensions maximizes workspace.
- Small footprint and curved design ensure comfortable loading and unloading of samples and cleaning of the unit.

- **High Rotor Speed**

- Powerful combination of motor and rotor, results in high speed up to 15000 rpm/21,380 x g for MCV / MCR, 16000 rpm/24320 x g for TCR, and 15000 rpm/ 21382 x g for TCV.



- **Large Capacity**

- Diverse specifications of rotors, make capacity respectively ranges from the minimum of 4 x 8 PCR strips (4 x 8 x 0.2 ml) to the maximum of 44 x 1.5 / 2.0 ml for MCV / MCR, and from the minimum of 24 x 1.5 ml / 2 ml to the maximum of 6 x 250 ml for TCV / TCR.

- **Incredible Flexibility**

- Wide choice of easy and interchangeable rotors meets all your application needs using microliter, blood sample and Falcon type conical tubes. Huge selection of adapters allows centrifugation of practically all commercially available tubes.

Powerful Refrigeration System (for MCR and TCR)

- **Environment-Friendly Refrigeration Technology**

- Designed with CFC-free refrigeration system, causes no harm to the atmosphere.

- **High Temperature Ramp Rate**

- Compressor in Versati™ centrifuges has strong power which allows fast cooling rate. The time cost can be as low as 10 mins when temperature decreases from room temperature to 4°C.

- **Wide Range of Temperature**

- Versati™ centrifuges does not only have a cooling function, but also a heating function. The temperature range is from -20°C to +40°C.

- **Perfect Performance**

- Swing-bucket rotors for TCR can be spun at maximum speed and still maintain -2°C.

- **Fast Pre-cooling**

- If the samples are temperature-sensitive, it is useful to pre-cool the centrifuge, the rotor and eventually the buckets to the needed working temperature. Versati™ centrifuges provide fast pre-cooling function (about 10 mins) that is maintained even when centrifuge is not in use.

Superior Safety

- **Genuine-Protect™ Safety Lid Design**

- Lid with motor-driven design ensuring safety of users from accidental release of aerosols and probable misuse.

- **V-balance™ Weight Imbalance Protection**

- Versati™ centrifuges are equipped with active weight imbalance-identification system. In case the rotor is not equally loaded, the drive will turn off during acceleration and the rotor will then decelerate to a stop.

- **Overspeed Protection**

- Equipped with speed detection system, Versati™ centrifuges show the actual speed on the screen. Once the speed exceeds the safety range, the alarm will sound off and rotation is halted.

- **Over Temperature Protection**

- With an overtemperature alarm for the chamber, rotor, and frequency converter. Once an over temperature is detected, the unit will stop running. This provides comprehensive protection which prolong the life span of Versati™ centrifuges.

- **Aerosol-tight and Autoclavable**

- High-quality, extremely robust aluminum lid of rotor allows aerosol-tight centrifugation. Rotor, buckets, lids, and adapters are autoclavable (20 min, 121°C) to ensure sterility of the centrifuge environment.

- **Alarm System**

- Audible and visual alarms are activated during system failures and error message is displayed on LCD for troubleshooting.

- **Safety Standards Followed**

- Machines are all manufactured according to international safety regulations, such as IEC 61010, EN61010-1, EN61010-2-2, and ISO9001, ISO13458, CE.

Versati™

MCV and MCR • TCV and TCR • Centrifuge

Humanization Designed Versati™ Controller

Versati™ centrifuges with bright back-lit LCD, simple intuitive key entry and unique turning knob for fast value setting are convenient in operation even with gloves on; greatly saves time for users.

MCR / TCR Model:

Alphanumeric Screen that displays all the parameters and status of the centrifuge.

Set Button - allows to set up the program with accuracy and precaution.

Open Button - allows easy access and one-hand operation of the lid.

Short Button - quick access to centrifugation without entering any set up program.

Store Button - allows all the desired and important settings to be saved.



Speed Button - enables user to control the speed and g-force of the centrifugation.

Select Button - allows user to choose the acceleration and deceleration intensity option.

Temperature Button - an option for the refrigerated centrifuge to set the temperature in the chamber.

Time Button - controls the duration of the run.

Start/Stop Button - these buttons give control to the user to start and stop the run.

Adjusting Knob - allows user to navigate and regulate the desired setting for each option of the program.

MCV / TCV Model:

Alphanumeric screen that displays all the parameters and status of the centrifuge.

Set Button - allows to set up the program with accuracy and precaution.

Open Button - allows easy access and one-hand operation of the lid.

Short Button - quick access to centrifugation without entering any set up program.

Store Button - allows all the desired and important settings to be saved.

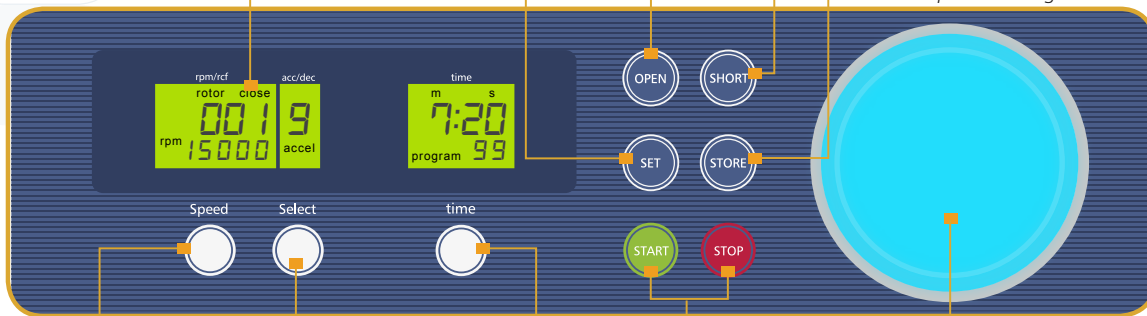

Speed Button - enables user to control the speed and g-force of the centrifugation.

Select Button - allows user to choose the acceleration and deceleration intensity option.

Time Button - controls the duration of the run.

Start/Stop Button - these buttons give control to the user to start and stop the run.

Adjusting Knob - allows user to navigate and regulate the desired setting for each option of the program.

• Smartdrive™ Rotor Auto Recognition

- Interchangeable rotors can be automatically recognized (for TCV / TCR only) and each rotor can only be set and run at the permitted maximum speed to protect the motor system with longer lifespan.

• Large Storage Space

- Versati™ centrifuges enable the users to edit and store up to 99 programs with combination of speed, centrifugal force, running time, temperature, acceleration/deceleration rate, radius correction, and rotor code which is enough for all users in a lab. A collection of pre-set values can be saved for quick and easy loading.

• Various Operation Mode

- Three types of spin mode : **short spin** for short running, **continuous spin** and **time-setting spin** (range from 10 s to 99 h 59 min) can be chosen to suit various applications.

• Automatic Conversion between Speed and RCF

- Users can set either the rotor speed or the centrifugal force which is automatically converted by the system from one parameter to another for different requirements.

• Acceleration/ Deceleration

- To provide more choices for users to suit their experiment demands, Versati™ centrifuges offer 10 different types of acceleration/ deceleration rate options.

• Notification System

- Once the run is complete, an audible alarm reminds users to take out samples. It has a total of 10 different sounds to choose from

• Automatic Switch of Temperature Types

- Versati™ centrifuges allow automatic conversions between degree Celsius and Fahrenheit.

• Real Time Modification of Parameter

- The parameters like rotary speed, RCF, running time, acceleration/ deceleration rate, and temperature can be adjusted during the operation to improve your working efficiency.

Guide to Models, Micro Centrifuge

MCV - 88 - 8

Model	Code	Centrifuge Capacity	Code	Electrical Supply	Code
Micro Centrifuge Ventilated	MCV	Maximum Sample Capacity (ml)	88	230 VAC 50/60 Hz	8
				120 VAC 50/60 Hz	9
Micro Centrifuge Refrigerated	MCR			230 VAC 50/60 Hz	8
				120 VAC 50/60 Hz	9

MCV / MCR High Speed Micro Centrifuge for up to 15,000 rpm

Designed to accelerate your routine sample preparation processes.

ORDERING INFORMATION

Model Code	Item Code	Description
MCV - 88 - 8	2220001	Micro Centrifuge Ventilated 230 VAC, 50/60 Hz
MCV - 88 - 9	2220002	Micro Centrifuge Ventilated 120 VAC, 50/60 Hz
MCR - 88 - 8	2220003	Micro Centrifuge Refrigerated 230 VAC, 50/60 Hz
MCR - 88 - 9	2220004	Micro Centrifuge Refrigerated 120 VAC, 50/60 Hz

Guide to Models, Tabletop Centrifuge

TCV - 1500 - 8

Model	Code	Centrifuge Capacity	Code	Electrical Supply	Code
Tabletop Centrifuge Ventilated	TCV	Maximum Sample Capacity (ml)	1500	230 VAC 50/60 Hz	8
				120 VAC 50/60 Hz	9
Tabletop Centrifuge Refrigerated	TCR			230 VAC 50/60 Hz	8
				120 VAC 50/60 Hz	9

TCV / TCR High Speed Tabletop Centrifuge for up to 16,000 rpm

Ideal for multi-purpose centrifugation at high-speed.

ORDERING INFORMATION

Model Code	Item Code	Description
TCV-1500-8	2220005	Tabletop Centrifuge Ventilated 230 VAC, 50/60 Hz
TCV-1500-9	2220006	Tabletop Centrifuge Ventilated 120 VAC, 50/60 Hz
TCR-1500-8	2220007	Tabletop Centrifuge Refrigerated 230 VAC, 50/60 Hz
TCR-1500-9	2220008	Tabletop Centrifuge Refrigerated 120 VAC, 50/60 Hz

Rotors and Adapters for Centrifuges MCV and MCR

FIXED-ANGLE ROTOR	
Model No.	VST - ROT - 001
Item Code	1380005
Number of Tubes and Tube Capacity	24 x 1.5 / 2.0 ml
Tube type (without adapter)	Conical/ Dome
Acceleration	21 - 152 seconds
Deceleration	18 - 173 seconds
Length	40 mm (1.6")
Angle	45°
Maximum Radius	85 mm (3.4")
Maximum Bore	11 mm \varnothing (0.4" \varnothing)
Maximum RCF	21380 x g
Maximum Speed	15000 rpm
Temperature at Maximum Speed	6°C



- 0.5 ml and 2.0 ml / 0.4 ml PCR tubes can be centrifuged with adapters in the fixed-angle rotor
- Rotor, lid and adapters are autoclavable (maximum of 121°C, 20 minutes)

Adapter Model No.	VST - ADP - 001	VST - ADP - 002
Item Code	1380013	1380014
Number of Tubes and Tube Capacity	1 x 0.5 ml	1 x 0.4 / 0.2 ml PCR
Tube type (inside the adapter)	Conical	
Adapter type	Flat	
Total Number of Tubes per Rotor	24	
Adapter Bore	8 mm \varnothing (0.3" \varnothing)	6 mm \varnothing (0.2" \varnothing)
Tube Length	45 mm (1.8")	

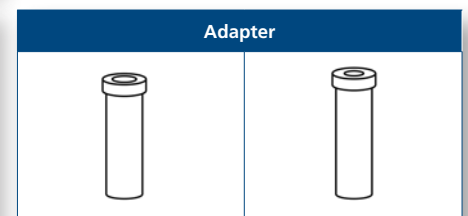

FIXED-ANGLE ROTOR	
Model No.	VST - ROT - 002
Item Code	1380006
Number of Tubes and Tube Capacity	24 x 1.5 / 2.0 ml
Tube type (without adapter)	Conical/ Dome
Acceleration	21 - 151 seconds
Deceleration	21 - 217 seconds
Length	40 mm (1.6")
Angle	45°
Maximum Radius	85 mm (3.4")
Maximum Bore	11 mm \varnothing (0.4" \varnothing)
Maximum RCF	21380 x g
Maximum Speed	15000 rpm
Temperature at Maximum Speed	4°C



- 0.5 ml and 2.0 ml / 0.4 ml PCR tubes can be centrifuged with adapters in the fixed-angle rotor
- High quality, extremely robust aluminum lid for rotor
- Aerosol-tight centrifugation
- Rotor, lid and adapters are autoclavable (maximum of 121°C, 20 minutes)
- TUV Nord Bioseal Rotor Certified

Adapter Model No.	VST - ADP - 001	VST - ADP - 002
Item Code	1380013	1380014
Tubes and Maximum Capacity	1 x 0.5 ml	1 x 0.4 / 0.2 ml PCR
Tube type (inside the adapter)	Conical	
Adapter type	Flat	
Total Number of Tubes per Rotor	24	
Adapter Bore	8 mm \varnothing (0.3" \varnothing)	6 mm \varnothing (0.2" \varnothing)
Tube Length	45 mm (1.8")	

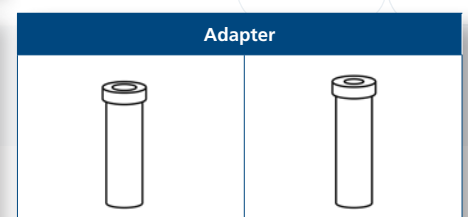

ESCO

WORLD CLASS. WORLDWIDE.

FIXED-ANGLE ROTOR	
Model No.	VST - ROT - 003
Item Code	1380007
Number of Tubes and Tube Capacity	30 x 1.5 / 2.0 ml
Tube type (without adapter)	Conical/ Dome
Acceleration	29 - 235 seconds
Deceleration	27 - 258 seconds
Length	11 mm (0.4")
Angle	45°
Maximum Radius	94 mm (3.7")
Maximum Bore	11 mm \varnothing (0.43" \varnothing)
Maximum RCF	19151 x g
Maximum Speed	13500 rpm
Temperature at Maximum Speed	7°C



- 0.5 ml and 1.5 ml / 2.0 ml PCR tubes can be centrifuged with adapters in the fixed-angle rotor
- Rotor, lid and adapters are autoclavable (maximum of 121°C, 20 minutes)

Adapter Model No.	VST - ADP - 001	VST - ADP - 002
Item Code	1380013	1380014
Number of Tubes and Tube Capacity	1 x 0.5 ml	1 x 0.4 / 0.2 ml PCR
Tube type (inside the adapter)	Conical	
Adapter type	Flat	
Total Number of Tubes per Rotor	24	
Adapter Bore	8 mm \varnothing (0.3" \varnothing)	6 mm \varnothing (0.2" \varnothing)
Tube Length	45 mm	

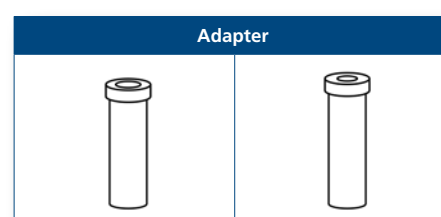

FIXED-ANGLE ROTOR	
Model No.	VST-ROT-004
Item Code	1380008
Number of Tubes and Tube Capacity	44 x 1.5 / 2.0 ml
Tube type (without adapter)	Conical/ Dome
Acceleration	18 - 136 seconds
Deceleration	17 - 133 seconds
Length	11 mm (0.43")
Angle	32° / 55°
Maximum Radius	84 mm (3.30") outer slots / 85 mm (3.34") inner slots
Maximum Bore	11 mm \varnothing (0.43" \varnothing)
Maximum RCF	17113 x g (outer slots) / 17317 x g (inner slots)
Maximum Speed	13500 rpm
Temperature at Maximum Speed	7°C



- 0.5 ml and 1.5 ml / 2.0 ml PCR tubes can be centrifuged with adapters in the fixed-angle rotor
- Rotor, lid and adapters are autoclavable (maximum of 121°C, 20 minutes)

Adapter Model No.	VST - ADP - 001	VST - ADP - 002
Item code	1380013	1380014
Number of Tubes and Tube Capacity	1 x 0.5 ml	1 x 0.4 / 0.2 ml PCR
Tube type (inside the adapter)	Conical	
Adapter type	Flat	
Total Number of Tubes per Rotor	24	
Adapter Bore	8 mm \varnothing (0.3" \varnothing)	6 mm \varnothing (0.2" \varnothing)
Tube Length	45 mm	

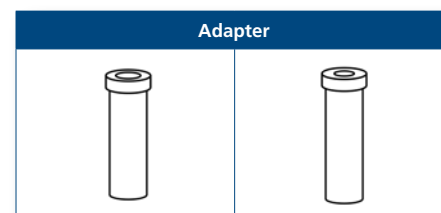

FIXED-ANGLE ROTOR	
Model No.	VST - ROT - 006
Item Code	1380010
Number of Tubes and Tube Capacity	12 x 5 ml
Tube type (without adapter)	Conical
Acceleration	24 - 148 seconds
Deceleration	17 - 320 seconds
Length	60 mm (2.4")
Angle	45°
Maximum Radius	85 mm (3.3")
Maximum Bore	17 mm \varnothing (0.07" \varnothing)
Maximum RCF	19978 x g
Maximum Speed	14500 rpm
Temperature at Maximum Speed	4 °C



- 1.0 ml, 1.8 ml and 1.5 ml / 2.0 ml PCR tubes can be centrifuged with adapters in this fixed-angle rotor
- Rotor, lid and adapters are autoclavable (maximum of 121°C, 20 minutes)

Adapter Model No.	VST - ADP - 003	VST - ADP - 004	VST - ADP - 005
Item code	1380015	1380016	1380017
Number of Tubes and Tube Capacity	1 x 1.5/ 2.0 ml	1 x 1.0 ml	1 x 1.8 ml
Tube type (inside the adapter)	Conical/ Dome	Flat cryo tube	Dome cryo tube
Adapter type	Holed	Conical	
Total Number of Tubes per Rotor	12		
Adapter Bore	11 mm \varnothing (0.43" \varnothing)	12.6 mm \varnothing (0.5" \varnothing)	
Tube Length	42 mm (1.7")	41 mm (1.6")	48 mm (1.9")

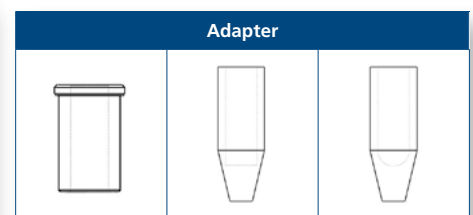

FIXED-ANGLE ROTOR	
Model No.	VST - ROT - 007
Item Code	1380011
PCR Strips	4 x 8 (0.2 ml)
Acceleration	17 - 150 seconds
Deceleration	20 - 95 seconds
Angle	45°
Maximum Radius	61 mm (2.4")
Maximum Bore	6 mm \varnothing (0.2" \varnothing)
Maximum RCF	15343 x g
Maximum Speed	15000 rpm
Temperature at Maximum Speed	2.5°C



- Only suitable with 0.2 ml 8 PCR strips, no adapter
- Rotor and lid are autoclavable (maximum of 121°C, 20 minutes)

HEMATOCRIT ROTOR	
Model No.	VST - ROT - 008
Item Code	1380012
Capillaries	24
Acceleration	15 - 120 seconds
Deceleration	15 - 120 seconds
Angle	90°
Maximum Radius	93 mm (3.7")
Capillary Tube Dimension (\varnothing x Length)	1.6 x 75 mm
Maximum RCF	14970 x g
Maximum Speed	12000 rpm



- Only for MCV centrifuge, not applicable with MCR
- Ideal for medical field in the determination of Hematocrit value

Model No.	VST - ACS - 005
Item Code	1380075
Description	Reading device for hematocrit value

Rotors and Adapters for Centrifuges TCV and TCR

SWING-BUCKET ROTOR	
Model No.	VST - ROT - 009
Item Code	1380022
Rotor Max. Capacity	4 x 250 ml
Bucket type	Circular flat-bottom
Acceleration	34 - 309 seconds
Deceleration	36 - 458 seconds
Angle	0-90°
Maximum Radius	167 mm (6.6")
Maximum RCF	3780 x g
Maximum Speed	4500 rpm
Temperature at Maximum Speed	-2°C



- 4 x 250 ml bucket with flexible adapters enable high sample for testing
- Ideal for medical and biotechnology laboratories
- Rotor, cap, buckets, adapters and caps are autoclavable (maximum 121°C, 20 minutes)

PC - SCREW CAP	
Model No.	VST - ACS - 009
Item Code	1380079



- Screw cap made of Polycarbonate (PC) for VST-ADP-006 to VST-ADP-021 of VST-ROT-009
- Used with O-rings for aerosol-tight application

O-RING	
Model No.	VST - ACS - 010
Item Code	1380080
Description	O-ring for bucket VST-ADP-006 ~ VST-ADP-021

Adapter Model No.	VST - ADP - 006	VST - ADP - 007	VST - ADP - 008
Item code	1380033	1380034	1380035
Number of Tubes and Tube Capacity	1 x 250 ml	1 x 100 ml	3 x 50 ml
Tube type (inside the bucket)	Flat	Dome	
Total Number of Tubes per Rotor	4		12
Adapter Bore	62 mm \varnothing (2.4" \varnothing)	41 mm \varnothing (1.6" \varnothing)	29 mm \varnothing (1.1" \varnothing)
Tube Length	110 / 130 mm (4.3" / 5.1")	95 / 120 mm (3.7" / 4.7")	95 / 120 mm (3.7" / 4.7")

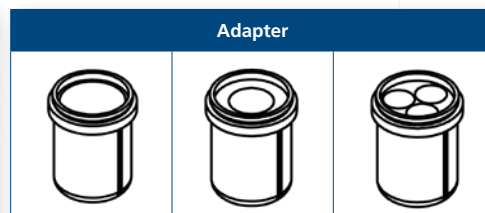

Adapter Model No.	VST - ADP - 009	VST - ADP - 010	VST - ADP - 011
Item code	1380036	1380037	1380038
Number of Tubes and Tube Capacity	5 x 25 ml	9 x 9ml/ 9 x 15ml	3 x 50 ml
Tube type (inside the bucket)	Dome		Conical
Total Number of Tubes per Rotor	20	36	12
Adapter Bore	24.5 mm \varnothing (1.0" \varnothing)	14 / 17 mm \varnothing (0.6" / 0.7" \varnothing)	29 mm \varnothing (1.1" \varnothing)
Tube Length	100 / 120 mm (3.9" / 4.7")	76 / 115 mm (3.0" / 4.5")	100 / 120 mm (3.9" / 4.7")

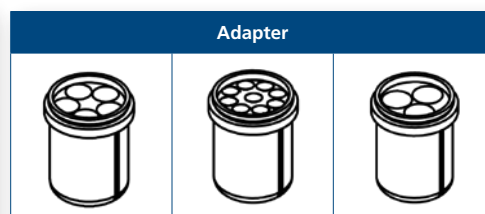

Adapter Model No.	VST - ADP - 012	VST - ADP - 013	VST - ADP - 014
Item code	1380039	1380040	1380041
Number of Tubes and Tube Capacity	2 x 50 ml	7 x 15 ml	1 x 50 ml
Tube type (inside the bucket)	Flat	Conical	Dome
Total Number of Tubes per Rotor	8	28	4
Adapter Bore	29 mm \varnothing rim (1.1" \varnothing rim)	17 mm \varnothing (0.7" \varnothing)	34 mm \varnothing (1.3" \varnothing)
Tube Length	100 / 120 mm (3.9" / 4.7")	95 / 120 mm (3.7" / 4.7")	100 / 120 mm (3.9" / 4.7")

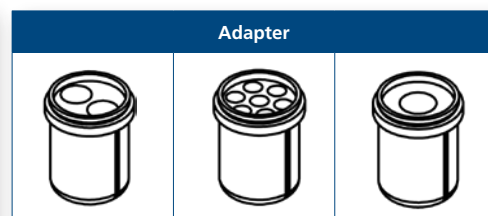

Adapter Model No.	VST - ADP - 015	VST - ADP - 016	VST - ADP - 017
Item code	1380042	1380044	1380043
Number of Tubes and Tube Capacity	1 x 50 ml	3 x 25 ml	7 x 15 ml
Tube type (inside the bucket)	Flat		
Total Number of Tubes per Rotor	4	12	28
Adapter Bore	29 mm \varnothing rim (1.1" \varnothing rim)	24.5 mm \varnothing (1.0" \varnothing)	17 mm \varnothing rim (0.7" \varnothing)
Tube Length	100 / 120 mm (3.9" / 4.7")	85 / 100 mm (3.3" / 3.9")	100 / 120 mm (3.9" / 4.7")

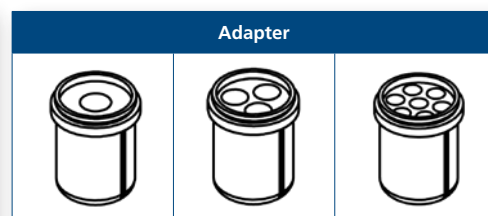

Adapter Model No.	VST - ADP - 018	VST - ADP - 019	VST - ADP - 020
Item code	1380045	1380046	1380047
Number of Tubes and Tube Capacity	8 x 10 ml	14 x 5 - 7 ml	10 x 6 - 7 ml
Tube type (inside the bucket)	Dome		Blood collection tubes
Total Number of Tubes per Rotor	32	56	40
Adapter Bore	16 mm \varnothing rim (0.6" \varnothing rim)	13 mm \varnothing (0.5" \varnothing)	
Tube Length	80 / 100 mm (3.1" / 3.9")	65 / 120 mm (2.6" / 4.7")	75 / 120 mm (3.0" / 4.7")

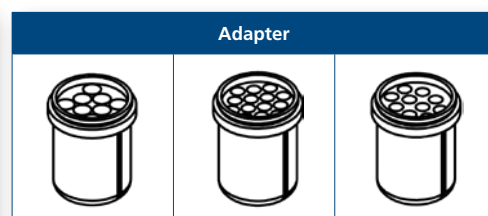

Adapter Model No.	VST - ADP - 021	VST - ADP - 022
Item code	1380048	1380049
Number of Tubes and Tube Capacity	8 x 4 - 10 ml	9 x 1.5 - 2 ml
Tube type (inside the bucket)	Blood collection tubes	Conical/ Dome
Total Number of Tubes per Rotor	32	36
Adapter Bore	16 mm \varnothing (0.6" \varnothing)	11 mm \varnothing (0.4" \varnothing)
Tube Length	75 / 100 mm (3.0" / 3.9")	38 mm (1.5")

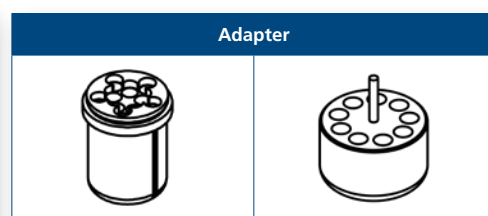

• Used with VST-ADP-006

MICROTITER SWING-BUCKET ROTOR	
Model No.	VST - ROT - 010
Item Code	1380023
Maximum Capacity	2 x 3 MTP
Acceleration	43 - 452 seconds
Deceleration	38 - 616 seconds
Maximum Loading Height	63 mm (2.5")
Maximum Loading Weight	310 g
Angle	0-90°
Maximum Radius	120 mm (4.7")
Maximum RCF	2716 x g
Maximum Speed	4500 rpm
Temperature at Maximum Speed	-3°C



- With adapter, a total of up to 48 x 1.5 ml / 2.0 ml test tubes can be centrifuged at one time
- Rotor, cap, buckets/adapter are autoclavable (maximum of 121°C, 20 minutes)

Note: Please proceed to page 22 for Esco Microtiter Swing-bucket Rotor Guide

Model No.	VST-ADP-023 (Deep well plate)
Item Code	1380050
Number of Tubes and Tube Capacity	48 x 1.5/2.0 ml (Conical/ Dome)
Bores Diameter	11 mm
Length	40 mm
Total Number of Tubes per Rotor	96

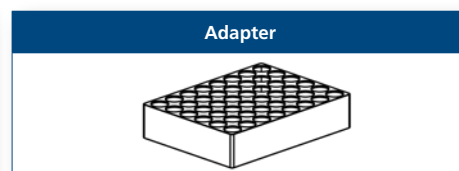

Adapter Model No.	VST - ACS - 012
Item Code	1380082
Description	Replacement carrier for rotor VST-ROT-010

FIXED-ANGLE ROTOR	
Model No.	VST - ROT - 011
Item Code	1380024
Number of Tubes and Tube Capacity	24 x 1.5 / 2.0 ml
Tube type (without adapter)	Conical/ Dome
Acceleration	25 - 251 seconds (1.5 ml) 30 - 249 seconds (2.0 ml)
Deceleration	26 - 610 seconds (1.5 ml) 27 - 635 seconds (2.0 ml)
Length	40 mm (1.6")
Angle	45°
Maximum Radius	85 mm (3.3")
Maximum Bore	11 mm ϕ (0.4" ϕ)
Maximum RCF	21380 / 24320 x g
Maximum Speed	15000 rpm (TCV) / 16000 rpm (TCR)
Temperature at Maximum Speed	3°C



- Microliter in volume and the highest speed among all the rotors
- Rotor, cap, buckets/adapters are autoclavable (maximum of 121°C, 20 minutes)

Adapter Model No.	VST - ADP - 001	VST - ADP - 002
Item code	1380013	1380014
Number of Tubes and Tube Capacity	1 x 0.5 ml	1 x 0.4 / 0.2 ml PCR
Tube type (inside the adapter)	Conical	
Adapter type	Flat	
Total Number of Tubes per Rotor	24	
Adapter Bore	8 mm ϕ (0.3" ϕ)	6 mm ϕ (0.2" ϕ)
Tube Length	45 mm (1.8")	

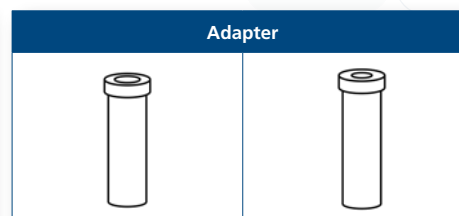

FIXED-ANGLE ROTOR	
Model No.	VST - ROT - 012
Item Code	1380025
Number of Tubes and Tube Capacity	24 x 1.5 / 2.0 ml
Tube type (without adapter)	Conical/ Dome
Acceleration	25 - 251 seconds (1.5 ml) 30 - 249 seconds (2.0 ml)
Deceleration	26 - 610 seconds (1.5 ml) 27 - 635 seconds (2.0 ml)
Length	40 mm (1.6")
Angle	45°
Maximum Radius	85 mm (3.3")
Maximum Bore	11 mm ϕ (0.4" ϕ)
Maximum RCF	21380 / 24320 x g
Maximum Speed	15000 rpm (TCV) / 16000 rpm (TCR)
Temperature at Maximum Speed	3°C



- Microliter in volume and the highest speed among all the rotors (sealable)
- Rotor, cap, buckets/adapters are autoclavable (maximum of 121°C, 20 minutes)
- Aerosol-tight centrifugation
- TUV Nord Bioseal Rotor Certified

Adapter Model No.	VST - ADP - 001	VST - ADP - 002
Item code	1380013	1380014
Number of Tubes and Tube Capacity	1 x 0.5 ml	1 x 0.4 / 0.2 ml PCR
Tube type (inside the adapter)	Conical	
Adapter type	Flat	
Total Number of Tubes per Rotor	24	
Adapter Bore	8 mm \varnothing (0.3" \varnothing)	6 mm \varnothing (0.2" \varnothing)
Tube Length	45 mm (1.8")	

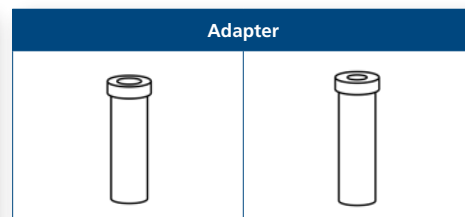

FIXED-ANGLE ROTOR	
Model No.	VST-ROT-013
Item Code	1380026
Number of Tubes and Tube Capacity	6 x 85 ml
Tube type (without adapter)	Dome
Acceleration	85 - 697 seconds
Deceleration	70 - 2313 seconds
Length	113 mm (4.4")
Angle	38°
Maximum Radius	115 mm (4.5")
Maximum Bore	38 mm \varnothing (1.5" \varnothing)
Maximum RCF	15550 x g (TCV) / 21730 x g (TCR)
Maximum Speed	11000 rpm (TCV) / 13000 rpm (TCR)
Temperature at Maximum Speed	6°C



- Offer 7 different adapters suitable with tubes of 15, 30, 50, 85 ml
- Rotor, cap, buckets/adapters are autoclavable (maximum 121°C, 20mins)

Adapter Model No.	VST - ADP - 024	VST - ADP - 025	VST - ADP - 026
Item code	1380051	1380052	1380053
Number of Tubes and Tube Capacity	2 x 15 ml	1 x 15 ml	1 x 30 ml
Tube type (inside the adapter)	Dome		
Adapter type	Dome		
Total Number of Tubes per Rotor	12	6	
Adapter Bore	17 mm \varnothing rim (0.7" \varnothing rim)		25 mm \varnothing (1.0" \varnothing)
Tube Length	95 / 100 mm (3.7" / 3.9")	103 / 110 mm (4.1" / 4.3")	90 / 103 mm (3.5" / 4.1")

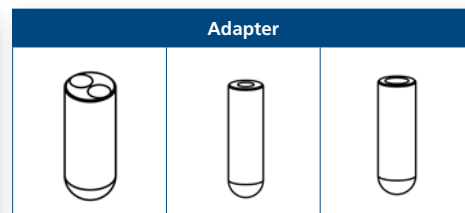

Adapter Model No.	VST - ADP - 027	VST - ADP - 028	VST - ADP - 031
Item code	1380054	1380055	1380058
Number of Tubes and Tube Capacity	1 x 50 ml	1 x 50 ml	1 x 15 ml
Tube type (inside the adapter)	Dome	Conical	
Adapter type	Dome		
Total Number of Tubes per Rotor	6		
Adapter Bore	29 mm \varnothing rim (1.1" \varnothing rim)		17 mm \varnothing (0.7" \varnothing)
Length	105 mm (4.1")	118 mm (4.6")	120 mm (4.7")

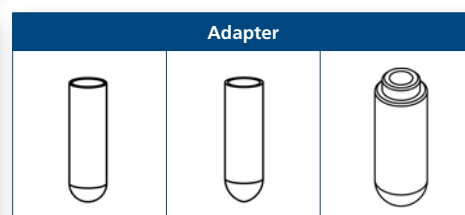

Adapter Model No.	VST - ADP - 032
Item Code	1380059
Number of Tubes and Tube Capacity	1 x 16 ml
Tube type (inside the adapter)	Conical
Adapter type	Dome
Total Number of Tubes per Rotor	6
Adapter Bore	18 mm \varnothing (0.7" \varnothing)
Tube Length	103/110 mm (4.1" / 4.3")

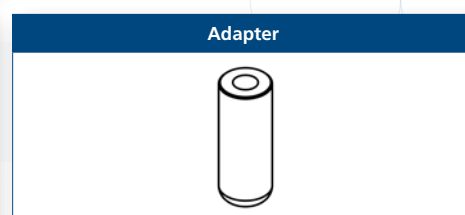

ESCO

WORLD CLASS. WORLDWIDE.

FIXED-ANGLE ROTOR	
Model No.	VST-ROT-014
Item Code	1380027
Number of Tubes and Tube Capacity	30 x 15 ml
Tube type (without adapter)	Conical/ Dome
Acceleration	25 - 149 seconds
Deceleration	20 - 985 seconds
Length	120 mm (4.7")
Angle	35°
Maximum Radius	125 mm (4.9") outer slots / 109 mm (4.3) inner slots
Maximum Bore	17 mm \varnothing (0.7" \varnothing)
Maximum RCF	2830 x g (outer slots) / 2468 x g (inner slots)
Maximum Speed	4500 rpm
Temperature at Maximum Speed	-12°C



- Mainly for hospital use in centrifugation of urine and blood
- Rotor, adapter, buckets/adapters are autoclavable (maximum 121°C, 20 mins)

Adapter Model No.	VST-ADP -003	VST-ADP - 029	VST-ADP - 030
Item code	1380015	1380056	1380057
Number of Tubes and Tube Capacity	1 x 1.5/ 2.0 ml	1 x 4-7 ml	1 x 1.8-5 ml
Tube type (inside the adapter)	Conical/ Dome	Round (vacutainer tube)	
Adapter type	Holed	Dome	
Total No. of Tubes per Rotor	20		
Adapter Bore	11 mm \varnothing (0.43" \varnothing)	13.5 mm \varnothing rim (0.5" \varnothing rim)	
Tube Length	42 mm (1.7")	95 /115 mm (3.7"/4.5")	70/90 mm (2.6"/3.5")

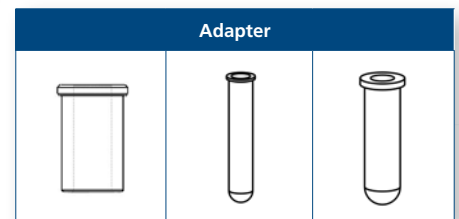

FIXED-ANGLE ROTOR	
Model No.	VST - ROT - 015
Item Code	1380028
Number of Tubes and Tube Capacity	4 x 85 ml
Tube type (without adapter)	Dome
Acceleration	60 - 506 seconds
Deceleration	49 - 1745 seconds
Length	113 mm (4.4")
Angle	30°
Maximum Radius	92 mm (3.6")
Maximum Bore	38 mm \varnothing (1.5" \varnothing)
Maximum RCF	14809 x g
Maximum Speed	12000 rpm
Temperature at Maximum Speed	5°C



- Applicable for samples of medium capacity such as bacterial culture
- Rotor, cap, buckets/adapters are autoclavable (maximum 121°C, 20 mins)

Adapter Model No.	VST - ADP - 025	VST - ADP - 026	VST - ADP - 027
Item code	1380052	1380053	1380054
Number of Tubes and Tube Capacity	1 x 15 ml	1 x 30 ml	1 x 50 ml
Tube type (inside the adapter)	Dome		
Adapter type	Dome		
Total Number of Tubes per Rotor	4		
Adapter Bore	17 mm \varnothing rim (0.7" \varnothing rim)	25 mm \varnothing (1.0" \varnothing)	29 mm \varnothing (1.14" \varnothing)
Tube Length	103/110 mm (4.1"/4.3")	90 / 103 mm (3.5"/4.3")	105 mm (4.1")

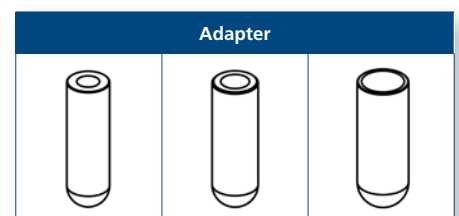

Adapter Model No.	VST - ADP - 028	VST - ADP - 031
Item code	1380055	1380058
Number of Tubes and Tube Capacity	1 x 50 ml	1 x 15 ml
Tube type (inside the adapter)	Conical	
Adapter type	Dome	
Total Number of Tubes per Rotor	4	
Adapter Bore	29 mm \varnothing (1.1" \varnothing)	17 mm \varnothing (0.7" \varnothing)
Tube Length	118 mm (4.6")	120 mm (4.7")

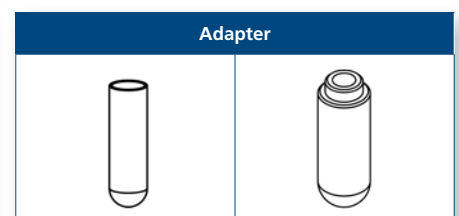

FIXED-ANGLE ROTOR	
Model No.	VST - ROT - 016
Item Code	1380029
Number of Tubes and Tube Capacity	6 x 250 ml
Tube type (without adapter)	Flat
Acceleration	130 - 664 seconds
Deceleration	92 - 2906 seconds
Length	122 mm (4.8")
Angle	28°
Maximum Radius	140 mm (5.5")
Maximum Bore	62 mm \varnothing (2.4" \varnothing)
Maximum RCF	10016 x g
Maximum Speed	8000 rpm
Temperature at Maximum Speed	3°C



- Has the biggest volume among all the rotors. Suitable to run samples with big volumes
- Rotor, buckets/adapters are autoclavable (maximum 121°C, 20 mins)

Adapter Model No.	VST - ADP - 038	VST - ADP - 039	VST - ADP - 040
Item code	1380065	1380066	1380067
Number of Tubes and Tube Capacity	8 x 1.5 ml	5 x 10 ml	4 x 15 ml
Tube type (inside the adapter)	Conical/ Dome	Dome	Conical
Adapter type	Flat		
Total Number of Tubes per Rotor	48	30	24
Adapter Bore	11 mm \varnothing (0.4" \varnothing)	16 mm (0.6")	17 mm \varnothing (0.7" \varnothing)
Tube Length	40 mm (1.6")	80 mm (3.1")	120 mm (4.7")

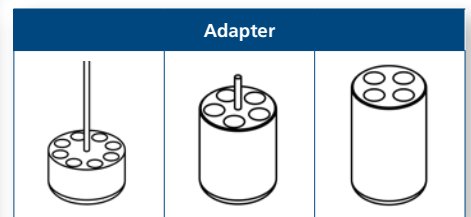

Adapter Model No.	VST - ADP - 041	VST - ADP - 042	VST - ADP - 043
Item code	1380068	1380069	1380070
Number of Tubes and Tube Capacity	2 x 30 ml	1 x 50 ml	1 x 50 ml
Tube type (inside the adapter)	Dome		Conical
Adapter type	Flat		
Total Number of Tubes per Rotor	12	6	6
Adapter Bore	26 mm \varnothing rim (1.02" \varnothing)	29 mm \varnothing (1.1" \varnothing)	30 mm \varnothing (1.2" \varnothing)
Tube Length	92 mm (3.6")	103 mm (4.1")	118 mm (4.6")

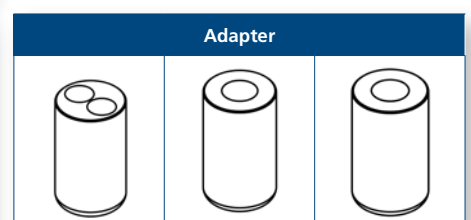

FIXED-ANGLE ROTOR	
Model No.	VST-ROT-017
Item Code	1380030
Number of Tubes and Tube Capacity	6 x 50 ml
Tube type (without adapter)	Dome
Acceleration	48 - 446 seconds
Deceleration	49 - 1323 seconds
Length	95 / 115 mm (3.7" / 4.5")
Angle	26°
Maximum Radius	84 mm (3.3")
Maximum Bore (\varnothing mm)	29 mm \varnothing (1.1" \varnothing)
Maximum RCF	15869 x g
Maximum Speed	13000 rpm
Temperature at Maximum Speed	0°C



- Has the capacity to centrifuge samples with medium volume; samples under 50 ml
- Rotor, cap, buckets/adapters are autoclavable (maximum 121°C, 20 mins)

Adapter Model No.	VST - ADP - 033	VST - ADP - 034	VST - ADP - 035	VST - ADP - 036
Item code	1380060	1380061	1380062	1380064
Number of Tubes and Tube Capacity	1 x 16 ml	1 x 15 ml	1 x 15 ml	1 x 30 ml
Tube type (inside the adapter)	Dome		Conical	Dome
Adapter type	Dome			
Total Number of Tubes per Rotor	6			
Adapter Bore	18 mm \varnothing (0.7" \varnothing)	17 mm \varnothing (0.67" \varnothing)	17.5 mm \varnothing (0.68" \varnothing)	25 mm \varnothing (1.0" \varnothing)
Tube Length	100 / 105 mm (3.9"/4.1")	100/105 mm (3.9"/4.)	116 / 125 mm (4.7"/4.9")	92 / 95 mm (3.6"/3.7")

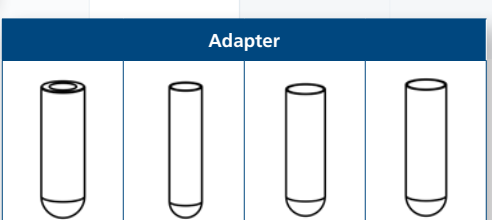

- Used only without rotor lid

FIXED-ANGLE ROTOR	
Model No.	VST-ROT-018
Item Code	1380031
Number of Tubes and Tube Capacity	20 x 10 ml
Tube type (without adapter)	Dome
Acceleration	54 - 512 seconds
Deceleration	47 - 1439 seconds
Length	80 mm (3.1")
Angle	30°
Maximum Radius	98 mm (3.9")
Maximum Bore	16 mm \varnothing (0.6" \varnothing)
Maximum RCF	15775 x g
Maximum Speed	12000 rpm
Temperature at Maximum Speed	0°C



- Rotor, cap, buckets/adapters are autoclavable (maximum 121°C, 20 mins)

FIXED-ANGLE ROTOR	
Model No.	VST-ROT-019
Item Code	1380032
Number of Tubes and Tube Capacity	10 x 50 ml
Tube type (without adapter)	Conical
Acceleration	115 - 753 seconds
Deceleration	72 - 2395 seconds
Length	118 mm (4.6")
Angle	38°
Maximum Radius	130 mm (5")
Maximum Bore	29 mm \varnothing (1.1" \varnothing)
Maximum RCF	11771 x g (TCV) / 16022 x g (TCR)
Maximum Speed	9000 rpm (TCV) / 10500 rpm (TCR)
Temperature at Maximum Speed	4°C



- Rotor, cap, buckets/adapters are autoclavable (maximum 121°C, 20 mins)

Adapter Model No.	VST-ADP-003	VST-ADP-029	VST-ADP-030	VST-ADP-049	VST-ADP-050
Item Code	1380015	1380056	1380057	1380178	1380179
Number of Tubes and Tube Capacity	1 x 1.5/ 2.0 ml	1 x 4-7 ml	1 x 1.8-5 ml	1 x 15 ml	1 x 15 ml
Tube type (inside the adapter)	Conical/ Dome	Round (vacutainer tube)		Conical	Dome
Adapter type	Holed	Dome		Conical	
Total Number of Tubes per Rotor	10				
Adapter Bore	11 mm \varnothing (0.43" \varnothing)	13.5 mm \varnothing rim (0.5" \varnothing rim)		17 mm \varnothing (0.7" \varnothing)	17 mm \varnothing (0.7" \varnothing)
Tube Length	42 mm (1.7")	95 /115 mm (3.7"/4.5")	70/90 mm (2.6"/3.5")	120 mm (4.7")	103/123 mm (4.1"/4.8")

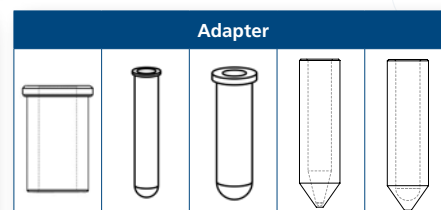

- VST-ADP-049 or VST-ADP-050 is required to use these adapters

SWING-BUCKET ROTOR	
Model No.	VST-ROT-020
Item Code	1380105
Number of Tubes and Tube Capacity	4 x 250 ml
Bucket type	Oval-shaped flat-bottom
Acceleration	34 - 316 seconds
Deceleration	36 - 240 seconds
Angle	0-90°
Maximum Radius	165 mm (6.6")
Maximum RCF	3735 x g
Maximum Speed	4500 rpm
Temperature at Maximum Speed	2°C



- Medium volume 4 x 250 ml bucket with adapter
- Rotor, buckets/adapters are autoclavable (maximum 121°C, 20 mins)

Adapter Model No.	VST - ADP - 044	VST - ADP - 045
Item Code	1380106	1380107
Number of Tubes and Tube Capacity	4 x 50 ml	10 x 15 ml
Tube type (inside the adapter)	Conical	
Adapter type	Flat	
Total Number of Tubes per Rotor	16	40
Adapter Bore	29 mm \varnothing (1.1" \varnothing)	17 mm \varnothing (0.7" \varnothing)
Tube Length	116 mm (4.6")	121 mm (4.8")

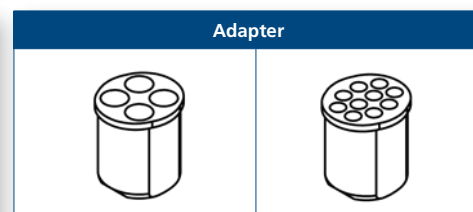

Adapter Model No.	VST - ADP - 046	VST - ADP - 047
Item Code	1380171	1380172
Number of Tubes and Tube Capacity	14 x 1.1-7 ml	12 x 6-10 ml
Tube type (inside the adapter)	Blood collection tubes	
Adapter type	Flat	
Total Number of Tubes per Rotor	56	48
Adapter Bore	13 mm \varnothing (0.5" \varnothing)	16 mm \varnothing (0.6" \varnothing)
Tube Length	75 / 100 mm (3.0" / 3.9")	92 / 100 mm (3.6" / 3.9")

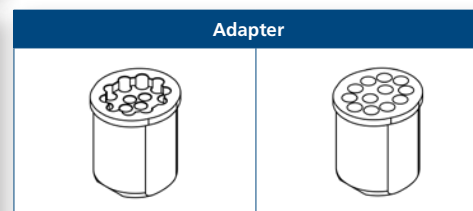

Adapter Model No.	VST - ADP - 022	VST - ADP - 048
Item Code	1380049	1380174
Number of Tubes and Tube Capacity	9 x 1.5 - 2 ml	1 x 250 ml
Tube type (inside the adapter)	Conical/ Dome	Flat
Adapter type	Flat	
Total Number of Tubes per Rotor	36	4
Adapter Bore	11 mm \varnothing (0.4" \varnothing)	62 mm \varnothing (2.4" \varnothing)
Tube Length	38 mm (1.5")	122 mm (4.8")

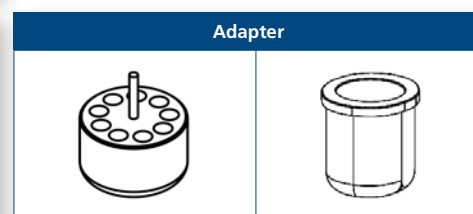

• Used with VST-ADP-048

TECHNICAL SPECIFICATION

Model	MCV-88-8	MCV-88-9	MCR-88-8	MCR-88-9	TCV-1500-8	TCV-1500-9	TCR-1500-8	TCR-1500-9	
Item Code	2220001	2220002	2220003	2220004	2220005	2220006	2220007	2220008	
External Dimensions (W x D x H)	280 x 389 x 304 mm (11" x 15" x 12")		280 x 563 x 294 mm (11" x 22" x 11.5")		438 x 532 x 374 mm (17" x 21" x 15")		715 x 528 x 373 mm (28" x 20.7" x 15")		
Maximum Relative Centrifugal Force	21380 x g				21382 x g		24320 x g		
Maximum Relative Centrifugal Force Swing-bucket Rotor					3780 x g				
Maximum Speed	15000 rpm				15000 rpm		16000 rpm		
Maximum Volume	44 x 1.5 / 2.0 ml				6 x 250 ml				
Rotor Options	7		6		12				
Speed Range	200 - 15000 rpm				200 - 15000 rpm		200 - 16000 rpm		
Acceleration / Deceleration Rates	10 / 10				10 / 10				
Programs Storage	99				99				
Temperature Range	Ambient		-20°C to +40°C		Ambient		-20°C to 40°C		
Time Set Range	99 hrs 59 mins / 59 min 50 s in 1min / 10s increments / continuous								
Maximum Noise Level (Depending on the rotor)	≤ 62 dB(A)		≤ 59 dB(A)		≤ 68 dB(A)		≤ 64 dB(A)		
Construction	Electrogalvanized steel with ISOCIDE™ antimicrobial powder-coated finish								
	Main Body								Chamber
	Plastic ABS		Stainless steel, grade 304						
Electrical Configuration	270 W 230 VAC, 50/60 Hz	280 W 120 VAC, 50/60 Hz	500 W 230 VAC, 50/60 Hz	560 W 120 VAC, 50/60 Hz	530 W 230 VAC, 50/60 Hz	520 W 120 VAC, 50/60 Hz	785 W 230 VAC, 50/60 Hz	850 W 120 VAC, 50/60 Hz	
Net Weight	17 kg (37 lbs)		35 kg (77 lbs)		49 kg (108 lbs)		73 kg (161 lbs)		
Shipping Weight	22 kg (49 lbs)		40 kg (88 lbs)		56 kg (123 lbs)		80 kg (176 lbs)		
Shipping Dimension (W x D x H)	650 x 670 x 550 mm (25.6" x 26.4" x 21.7")		410 x 680 x 400 mm (16.1" x 26.8" x 15.7")		720 x 860 x 690 mm (28.3" x 33.9" x 27.2")		650 x 830 x 580 mm (25.6" x 32.7" x 22.8")		
Shipping Volume, Maximum	0.24 m ³ (8.5 ft ³)		0.11 m ³ (3.9 ft ³)		0.42 m ³ (14.8 ft ³)		0.31 m ³ (10.9 ft ³)		

Noise Level per Rotor

Micro Centrifuge (Ventilated)	
Rotor No.	Noise Level
VST-ROT-001	≤ 58 dBA
VST-ROT-002	≤ 57 dBA
VST-ROT-003	≤ 59 dBA
VST-ROT-004	≤ 60 dBA
VST-ROT-006	≤ 53 dBA
VST-ROT-007	≤ 57 dBA
VST-ROT-008	≤ 62 dBA

Micro Centrifuge (Refrigerated)	
Rotor No.	Noise Level
VST-ROT-001	≤ 57 dBA
VST-ROT-002	≤ 56 dBA
VST-ROT-003	≤ 58 dBA
VST-ROT-004	≤ 59 dBA
VST-ROT-006	≤ 52 dBA
VST-ROT-007	≤ 56 dBA

Tabletop Centrifuge (Ventilated)	
Rotor No.	Noise Level
VST-ROT-009	≤ 67 dBA
VST-ROT-010	≤ 65 dBA
VST-ROT-011	≤ 54 dBA
VST-ROT-012	≤ 61 dBA
VST-ROT-013	≤ 61 dBA
VST-ROT-014	≤ 54 dBA
VST-ROT-015	≤ 59 dBA
VST-ROT-016	≤ 68 dBA
VST-ROT-017	≤ 57 dBA
VST-ROT-018	≤ 57 dBA
VST-ROT-019	≤ 67 dBA
VST-ROT-020	≤ 57 dBA

Tabletop Centrifuge (Refrigerated)	
Rotor No.	Noise Level
VST-ROT-009	≤ 56 dBA
VST-ROT-010	≤ 56 dBA
VST-ROT-011	≤ 60 dBA
VST-ROT-012	≤ 63 dBA
VST-ROT-013	≤ 57 dBA
VST-ROT-014	≤ 56 dBA
VST-ROT-015	≤ 59 dBA
VST-ROT-016	≤ 55 dBA
VST-ROT-017	≤ 64 dBA
VST-ROT-018	≤ 57 dBA
VST-ROT-019	≤ 54 dBA
VST-ROT-020	≤ 55 dBA

Esco Microtiter Swing-bucket Rotor Guide

VST-ROT-010

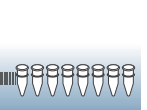
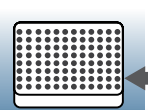
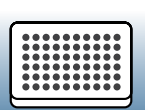
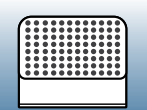
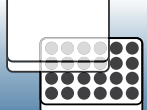
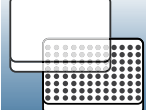
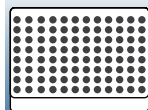

TYPE	Microtiter Plate	Microtiter Plate (with lid)	Culture Plate	*Deep Well Plate	Microsonic System	Microtest/Terasaki Plate	PCR Plate (96-well)	PCR Strip
Dimensions (WxDxH)	128 x 86 x 15 mm	128 x 86 x 17.5 mm	128 x 86 x 22 mm	128 x 86 x 44.5 mm	128 x 86 x 46 mm	84 x 59 x 11 mm	124 x 82 x 20 mm	-
Plates / Strips per Rotor	6	6	4	2	2	4	2	24 x 8
Max. Loading Weight (per carrier)	310 g							
Max. Loading Height	63 mm							

*Available in Esco (Item code: 1380050).

Versati™

MCV and MCR • TCV and TCR • Centrifuge

Industries where Laboratory Centrifuges are used:



ESCO GLOBAL NETWORK

42 LOCATIONS IN 21 COUNTRIES ALL OVER THE WORLD

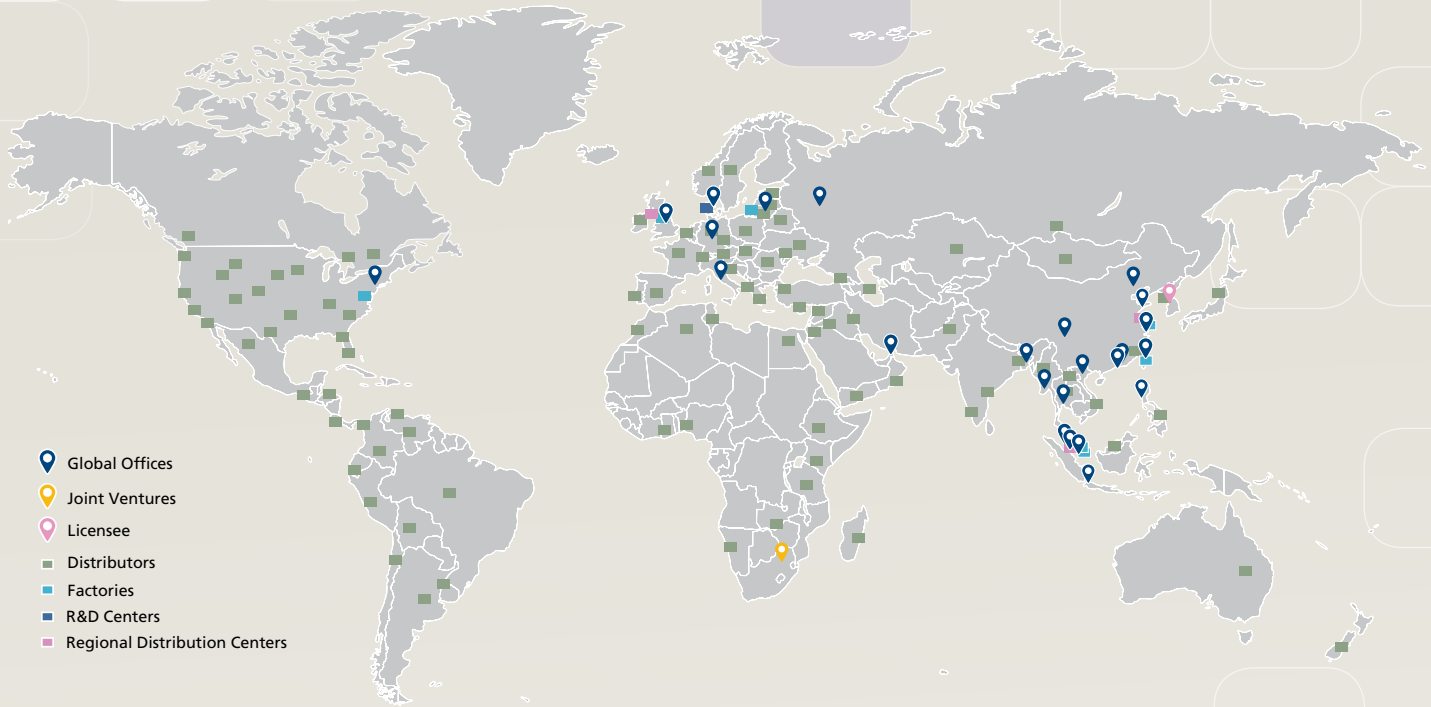

- ART Equipment
- Biological Safety Cabinets
- CO₂ Incubators
- Compounding Pharmacy Equipment
- Containment / Pharma Products
- Ductless Fume Hoods
- Lab Animal Research Products
- Laboratory Centrifuges
- Laboratory Fume Hoods
- Laboratory Ovens and Incubators
- Laboratory Shakers
- Laminar Flow Clean Benches
- PCR Cabinets
- PCR Thermal Cyclers
- Powder Weighing Balance Enclosures
- Ultra-low Temperature Freezers

The Esco Group of Companies is a global life sciences tools provider with sales in over 100 countries. The group is active in lab equipment, pharma equipment and medical devices. Manufacturing facilities are located in Asia and Europe. R&D is conducted worldwide spanning the US, Europe and Asia. Sales, service and marketing subsidiaries are located in 12 major markets including the US, UK, Singapore, Japan, China and India. Regional distribution centers are located in the US, UK, and Singapore.

Life Science • Chemical Research • Assisted Reproductive Technology (ART) • Pharmaceutical Equipment • General Equipment



WORLD CLASS. WORLDWIDE.

Esco Micro Pte. Ltd. • 21 Changi South Street 1 • Singapore 486 777
 Tel +65 6542 0833 • Fax +65 6542 6920 • mail@escoglobal.com
 www.escoglobal.com

Esco Technologies, Inc. • 903 Sheehy Drive, Suite F, Horsham, PA 19044, USA
 Tel: +1 215-441-9661 • Fax 484-698-7757
 eti.admin@escoglobal.com • www.escolifesciences.us

Esco Global Offices: Bangladesh | China | Denmark | Germany | Hong Kong | Indonesia | Italy | Lithuania | Malaysia | Myanmar | Philippines | Russia | Singapore | South Africa | South Korea | Taiwan | Thailand | UAE | UK | USA | Vietnam

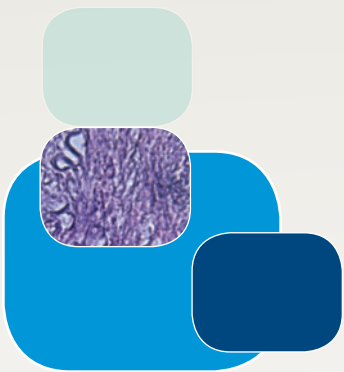

9010262, Vertical, Centrifuge, Brochure, A4, v. 030620
 Esco can accept no responsibility for possible errors in catalogue, brochures and other printed materials.
 In the event of any change in the information, Esco will be pleased to issue a new version without notice.
 All trademarks and logos are the property of Esco and its respective companies.

